

# Series BM-01 and BM-02



## Technical details

<b>Connection</b>	BM-01: G1/8 BM-02: G1/4
<b>Nominal size</b>	BM-01: 5 mm BM-02: 7 mm
<b>Temperature range</b>	-10°C ... +60°C
<b>Medium</b>	Filtered, oil-free and dried compressed air according to ISO 8573-1:2010, Class 7:2:4, instrument air, free of aggressive additives. Alternatively the pressure dew point must be at least 10°C below lowest occurring ambient temperature.
<b>Materials</b>	Body: Al (anodized), plastic, seals: NBR, FKM and PU, inner parts: Al, steel and plastic
<b>Protection</b>	IP 65 according to EN 60529



Electrically operated spool valve. The manual override is non-detent (HNT) or detent (HNR) and is operated by bolt or screwdriver.

### 3/2-way valves

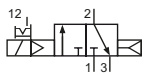

BM-01-310-HNR-xxx  
BM-02-310-HNR-xxx  
3/2-way, single solenoid, air spring return, NC

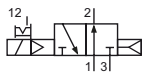

BM-01-312-HNR-xxx  
BM-02-312-HNR-xxx  
3/2-way, single solenoid, air spring return, NO

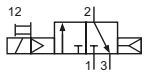

BM-01-310-HNT-xxx  
BM-02-310-HNT-xxx  
3/2-way, single solenoid, air spring return, NC

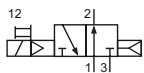

BM-01-312-HNT-xxx  
BM-02-312-HNT-xxx  
3/2-way, single solenoid, air spring return, NO

### 2 x 3/2-way valves

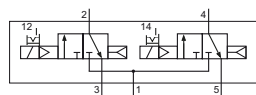

BM-01-310/2-HNR-xxx  
BM-02-310/2-HNR-xxx  
2 x 3/2-way, single solenoid, air spring return, NC

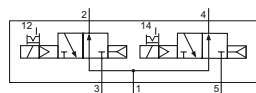

BM-01-312/2-HNR-xxx  
BM-02-312/2-HNR-xxx  
2 x 3/2-way, single solenoid, air spring return, NO

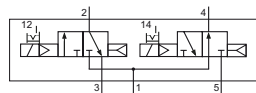

BM-01-314/2-HNR-xxx  
BM-02-314/2-HNR-xxx  
2 x 3/2-way, single solenoid, air spring return, 1 x NC, 1 x NO

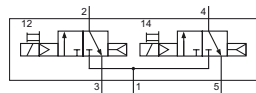

BM-01-310/2-HNT-xxx  
BM-02-310/2-HNT-xxx  
2 x 3/2-way, single solenoid, air spring return, NC

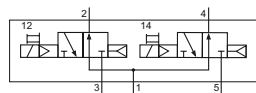

BM-01-312/2-HNT-xxx  
BM-02-312/2-HNT-xxx  
2 x 3/2-way, single solenoid, air spring return, NO

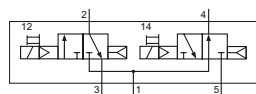

BM-01-314/2-HNT-xxx  
BM-02-314/2-HNT-xxx  
2 x 3/2-way, single solenoid, air spring return, 1 x NC, 1 x NO

Please complete: xxx = electrical option

## Electrical options

Nominal voltage	Power consumption	Specifics	Plug connection*1	-XXX electrical pins on same side of ports	
				2 or 2 and 4	1, 3 or 1, 3 and 5
12 V DC	1 W		Form C	-461	-431
24 V DC	1 W		Form C	-462	-432
24 V DC	1 W		M12	-N62	-
24 V AC	3 VA		Form C	-452	-422
115 V AC	3 VA		Form C	-456	-426
230 V AC	3 VA		Form C	-457	-427

\*1 Plug socket not included, suitable plug sockets see page 4-39.

**Technical data**

<b>Model-no.:</b>	BM-01-310	BM-01-312	BM-01-310/2	BM-01-312/2	BM-01-314/2
<b>Operating pressure (bar)</b>	2 ... 8	2 ... 8	2 ... 8	2 ... 8	2 ... 8
<b>Pilot pressure (bar)</b>	2 ... 8	2 ... 8	2 ... 8	2 ... 8	2 ... 8
<b>Flow rate (NI/min)</b>	660	600	650	550	580
<b>Response time (ms) at 6 bar</b>	on: 19 off: 32	on: 16 off: 30	on: 18 off: 34	on: 18 off: 34	on: 18 off: 34
<b>Weight (kg)</b>	0.108	0.110	0.154	0.154	0.154
<b>Model-no.:</b>	BM-02-310	BM-02-312	BM-02-310/2	BM-02-312/2	BM-02-314/2
<b>Operating pressure (bar)</b>	2 ... 8	2 ... 8	2 ... 8	2 ... 8	2 ... 8
<b>Pilot pressure (bar)</b>	2 ... 8	2 ... 8	2 ... 8	2 ... 8	2 ... 8
<b>Flow rate (NI/min)</b>	1090	920	1050	1030	NC: 1050. NO: 920
<b>Response time (ms) at 6 bar</b>	on: 19 off: 23	on: 25 off: 27	on: 22 off: 24	on: 22 off: 24	on: 22 off: 24
<b>Weight (kg)</b>	0.150	0.150	0.250	0.250	0.250

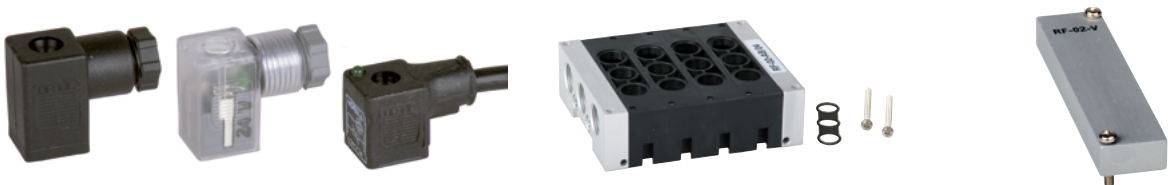
**Accessories**

Plug sockets: page 4-39

Manifolds and accessories: page 4-29

## Series BM-01 and BM-02

### Dimensions

#### BM-01-31x-HNx

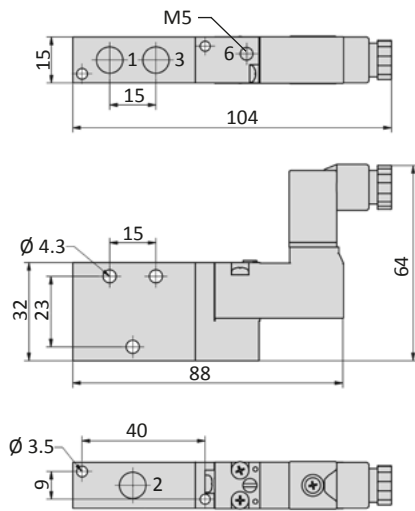

#### BM-01-31x/2-HNx

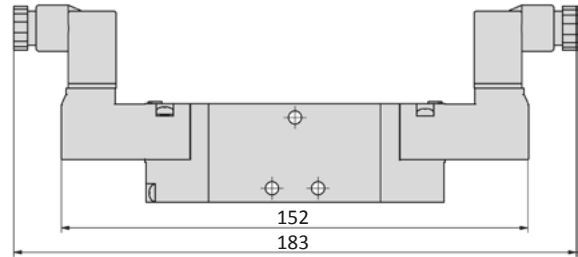

#### BM-02-31x-HNx

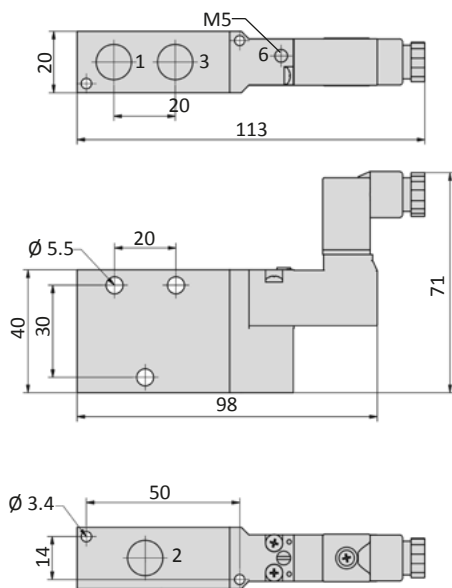

#### BM-02-31x/2-HNx

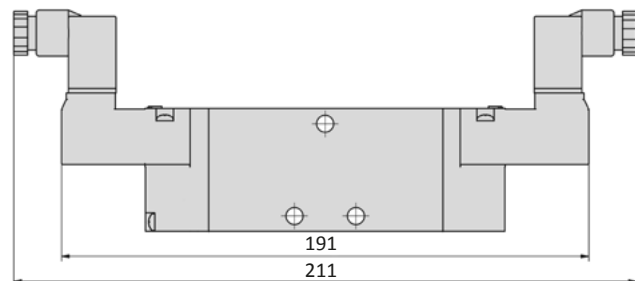

- 1 = pressure inlet
- 2,4 = outlets
- 3,5 = exhausts
- 6 = pilot air exhaust (only at BM-valves)
- 6 = external pilot pressure supply (only at BME-valves)

Plug socket (not included in scope of delivery) can be repositioned by 180°.

**Technical details**

<b>Connection</b>	BM-01: G1/8 BM-02: G1/4
<b>Nominal size</b>	BM-01: 5 mm BM-02: 7 mm
<b>Temperature range</b>	-10°C ... +60°C
<b>Medium</b>	Filtered, oil-free and dried compressed air according to ISO 8573-1:2010, Class 7:2:4, instrument air, free of aggressive additives. Alternatively the pressure dew point must be at least 10°C below lowest occurring ambient temperature.
<b>Materials</b>	Body: Al (anodized), plastic, seals: NBR, FKM and PU, inner parts: Al, steel and plastic
<b>Protection</b>	IP 65 according to EN 60529

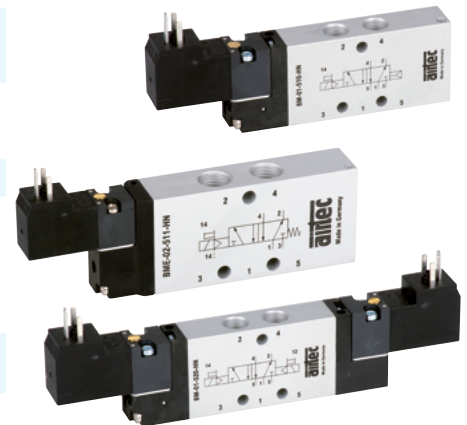

4

Electrically operated spool valve. The manual override is non-detent or detent and is operated by bolt or screwdriver.

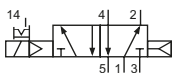
**5/2-way valves**

BM-01-510-HNR-xxx  
BM-02-510-HNR-xxx  
5/2-way, single solenoid, air spring return

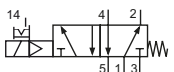

BM-01-511-HNR-xxx  
BM-02-511-HNR-xxx  
5/2-way, single solenoid, mechanical spring return

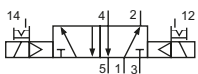

BM-01-520-HNR-xxx  
BM-02-520-HNR-xxx  
5/2-way, double solenoid

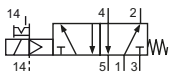

BME-01-511-HNR-xxx  
BME-02-511-HNR-xxx  
5/2-way, single solenoid, external pilot pressure, mechanical spring return

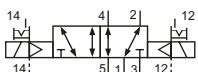

BME-01-520-HNR-xxx  
BME-02-520-HNR-xxx  
5/2-way, double solenoid, external pilot pressure

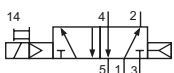

BM-01-510-HNT-xxx  
BM-02-510-HNT-xxx  
5/2-way, single solenoid, air spring return

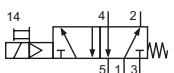

BM-01-511-HNT-xxx  
BM-02-511-HNT-xxx  
5/2-way, single solenoid, mechanical spring return

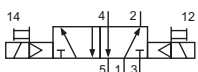

BM-01-520-HNT-xxx  
BM-02-520-HNT-xxx  
5/2-way, double solenoid

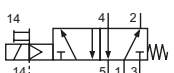

BME-01-511-HNT-xxx  
BME-02-511-HNT-xxx  
5/2-way, single solenoid, external pilot pressure, mechanical spring return



BME-01-520-HNT-xxx  
BME-02-520-HNT-xxx  
5/2-way, double solenoid, external pilot pressure

Please complete: xxx = electrical option

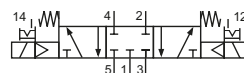
**5/3-way valves**

BM-01-530-HNR-xxx  
BM-02-530-HNR-xxx  
5/3-way, center position closed

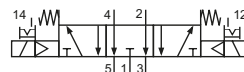

BM-01-533-HNR-xxx  
BM-02-533-HNR-xxx  
5/3-way, center position exhausted

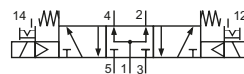

BM-01-534-HNR-xxx  
BM-02-534-HNR-xxx  
5/3-way, center position pressurized

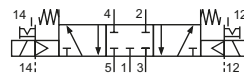

BME-01-530-HNR-xxx  
BME-02-530-HNR-xxx  
5/3-way, center position closed, external pilot pressure

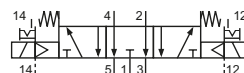

BME-01-533-HNR-xxx  
BME-02-533-HNR-xxx  
5/3-way, center position exhausted, external pilot pressure

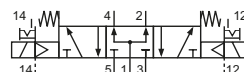

BME-01-534-HNR-xxx  
BME-02-534-HNR-xxx  
5/3-way, center position pressurized, external pilot pressure

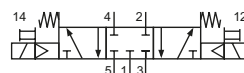

BM-01-530-HNT-xxx  
BM-02-530-HNT-xxx  
5/3-way, center position closed

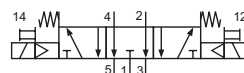

BM-01-533-HNT-xxx  
BM-02-533-HNT-xxx  
5/3-way, center position exhausted

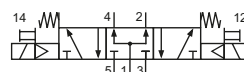

BM-01-534-HNT-xxx  
BM-02-534-HNT-xxx  
5/3-way, center position pressurized

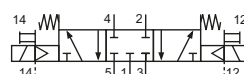

BME-01-530-HNT-xxx  
BME-02-530-HNT-xxx  
5/3-way, center position closed, external pilot pressure

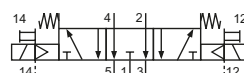

BME-01-533-HNT-xxx  
BME-02-533-HNT-xxx  
5/3-way, center position exhausted, external pilot pressure

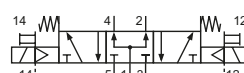

BME-01-534-HNT-xxx  
BME-02-534-HNT-xxx  
5/3-way, center position pressurized, external pilot pressure

## Series BM-01 and BM-02

### Electrical options

Nominal voltage	Power consumption	Specifics	Plug connection <sup>*1</sup>	-XXX electrical pins on same side of ports	
				2 and 4	1, 3 and 5
12 V DC	1 W		Form C	-461	-431
24 V DC	1 W		Form C	-462	-432
24 V DC	1 W		M12	-N62	-
24 V AC	3 VA		Form C	-452	-422
115 V AC	3 VA		Form C	-456	-426
230 V AC	3 VA		Form C	-457	-427

\*1 Plug socket not included. suitable plug sockets see page 4-39.

### Technical data

Model-no.:	BM-01-510	BM-01-511	BM-01-520	BME-01-511	BME-01-520
Operating pressure (bar)	2 ... 8	3 ... 8	2 ... 8	-0.95 ... 8	-0.95 ... 8
Pilot pressure (bar)	2 ... 8	3 ... 8	2 ... 8	3 ... 8	2 ... 8
Flow rate (NI/min)	780	800	790	800	790
Response time (ms) at 6 bar	on: 17 off: 32	on: 15 off: 35	on: 13 off: 13	on: 15 off: 35	on: 13 off: 13
Weight (kg)	0.118	0.120	0.156	0.126	0.168

Model-no.:	BM-01-530	BM-01-533	BM-01-534	BME-01-530	BME-01-533	BME-01-534
Operating pressure (bar)	3 ... 8	3 ... 8	3 ... 8	-0.95 ... 8	-0.95 ... 8	-0.95 ... 8
Pilot pressure (bar)	3 ... 8	3 ... 8	3 ... 8	3 ... 8	3 ... 8	3 ... 8
Flow rate (NI/min)	690	670	1030	690	670	1030
Response time (ms) at 6 bar	on: 17 off: 17	on: 16 off: 43	on: 17 off: 49	on: 17 off: 17	on: 16 off: 43	on: 17 off: 49
Weight (kg)	0.154	0.154	0.154	0.166	0.166	0.166

Model-no.:	BM-02-510	BM-02-511	BM-02-520	BME-02-511	BME-02-520
Operating pressure (bar)	2 ... 8	3 ... 8	2 ... 8	-0.95 ... 8	-0.95 ... 8
Pilot pressure (bar)	2 ... 8	3 ... 8	2 ... 8	3 ... 8	2 ... 8
Flow rate (NI/min)	1700	1600	1540	1600	1540
Response time (ms) at 6 bar	on: 23 off: 33	on: 13 off: 35	on: 11 off: 11	on: 13 off: 35	on: 11 off: 11
Weight (kg)	0.220	0.220	0.270	0.220	0.270

Model-no.:	BM-02-530	BM-02-533	BM-02-534	BME-02-530	BME-02-533	BME-02-534
Operating pressure (bar)	3 ... 8	3 ... 8	3 ... 8	-0.95 ... 8	-0.95 ... 8	-0.95 ... 8
Pilot pressure (bar)	3 ... 8	3 ... 8	3 ... 8	3 ... 8	3 ... 8	3 ... 8
Flow rate (NI/min)	1300	1470	1660	1300	1470	1660
Response time (ms) at 6 bar	on: 20 off: 26	on: 26 off: 28	on: 26 off: 33	on: 20 off: 26	on: 26 off: 28	on: 26 off: 33
Weight (kg)	0.260	0.260	0.260	0.260	0.260	0.260

Dimensions

BM-01-51x-HNx, BME-01-51x-HNx

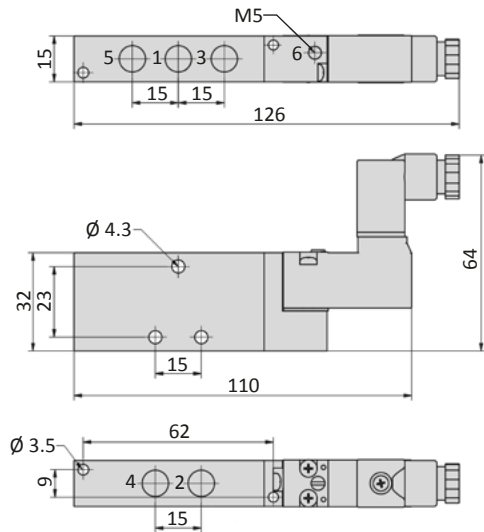

BM-01-520-HNx, BME-01-520-HNx, BM-01-53x-HNx, BME-01-53x-HNx

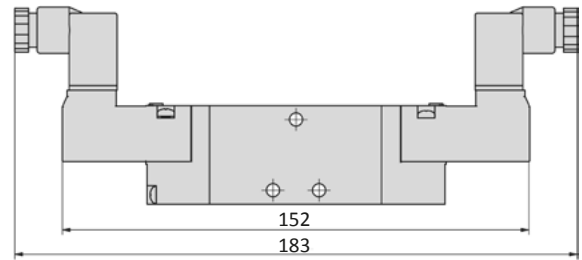

4

BM-02-51x-HNx, BME-02-51x-HNx

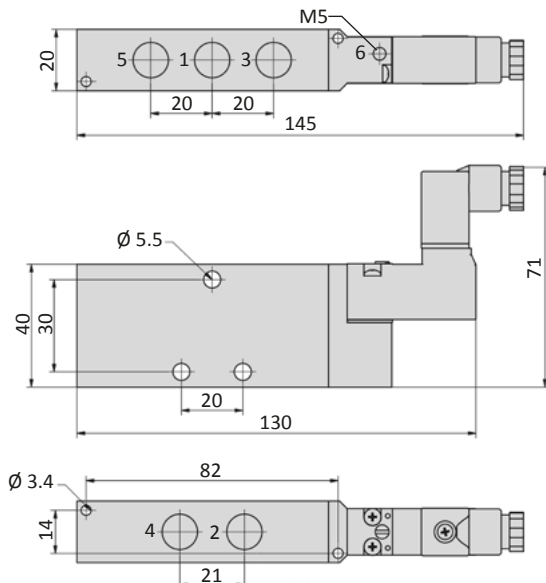

BM-02-520-HNx, BME-02-520-HNx, BM-02-53x-HNx, BME-02-53x-HNx

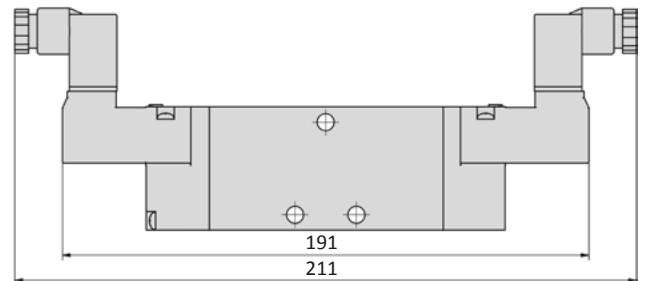

- 1 = pressure inlet
- 2,4 = outlets
- 3,5 = exhausts
- 6 = pilot air exhaust

Plug socket (not included in scope of delivery) can be repositioned by 180°.

Accessories



Plug sockets: page 4-39



Manifolds and accessories: page 4-29



# Series BM-01 and BM-02

## Dimensions

### BME-01-51x-HNx

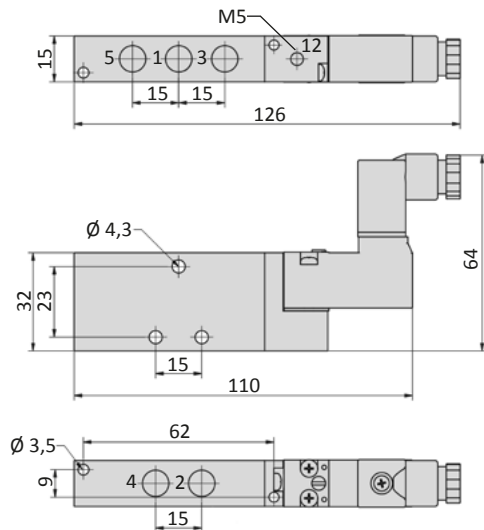

### BME-01-520-HNx, BME-01-53x-HNx

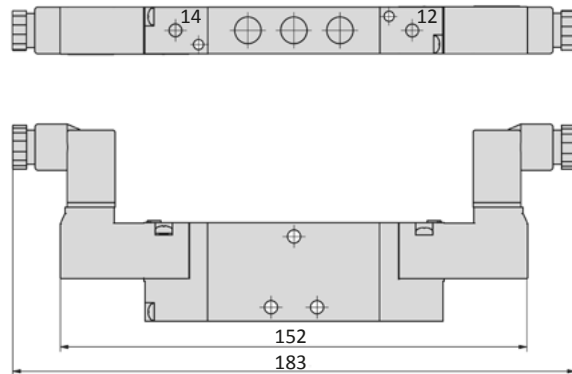

### BME-02-51x-HNx

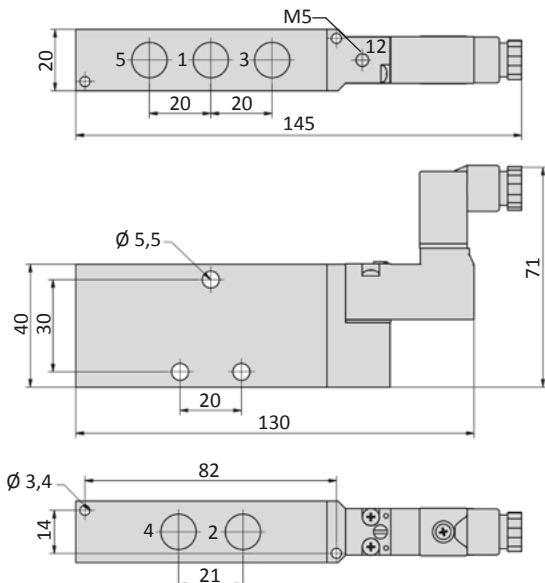

### BME-02-520-HNx, BME-02-53x-HNx

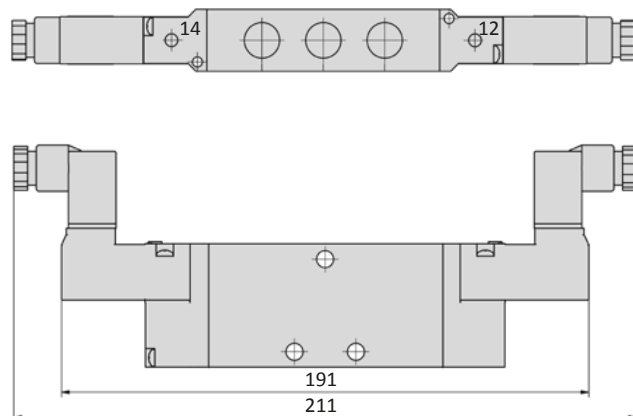

- 1 = pressure inlet
- 2,4 = outlets
- 3,5 = exhausts
- 12,14 = external pilot pressure supply

Plug socket (not included in scope of delivery) can be repositioned by 180°.

## Accessories



Plug sockets: page 4-39



Manifolds and accessories: page 4-29

# Series BM-01 and BM-02

## General information

The RF-01-xx/n and RF-02-xx/n manifolds are suitable for the BM-01 and BM-02 valve series. The system is modular and can be extended up to 12 stations. Blind plates RF-01-V and RF-02-V are available. All mounting screws and gaskets are included.



## Dimensions

### RF-01-AB, RF-02-AB

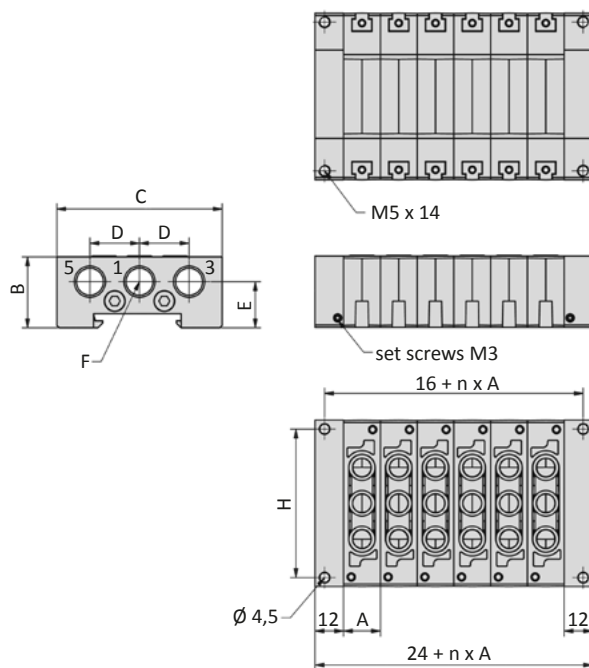

### RF-01-CD, RF-02-CD

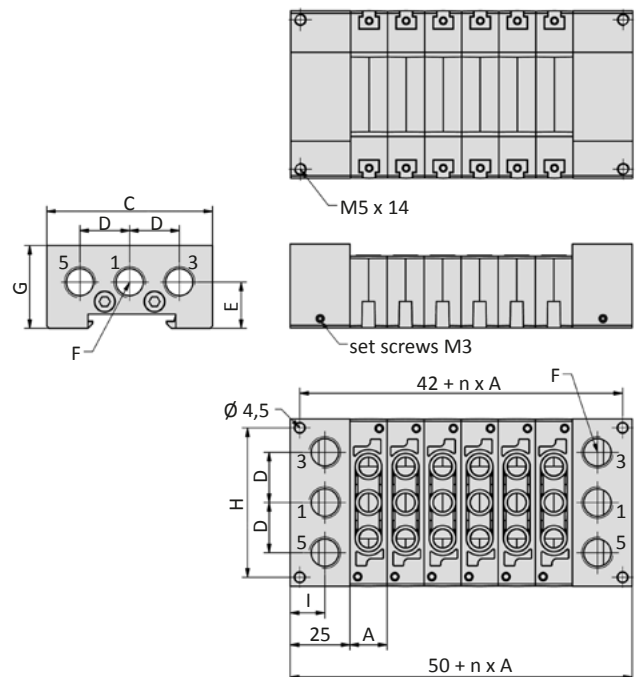

n = number of stations  
 1 = pressure inlet  
 3,5 = exhausts

Model-no.:	A	B	C	D	E	F	G	H	I
RF-01-xx/n	15.7	30	70	21	19.5	G1/4	35	62.5	14.5
RF-02-xx/n	20.5	32	90	25	20	G3/8	38	82	12.5

Model-no.:	nn	02	03	04	05	06	07	08	09	10	11	12
Weight (kg)	RF-01-AB/nn	0.150	0.190	0.230	0.270	0.310	0.350	0.390	0.430	0.470	0.510	0.550
	RF-02-AB/nn	0.230	0.270	0.310	0.350	0.390	0.430	0.470	0.510	0.550	0.590	0.630

Model-no.:	nn	02	03	04	05	06	07	08	09	10	11	12
Weight (kg)	RF-01-CD/nn	0.300	0.340	0.380	0.420	0.460	0.500	0.540	0.580	0.620	0.660	0.700
	RF-02-CD/nn	0.420	0.460	0.500	0.540	0.580	0.620	0.660	0.700	0.740	0.780	0.820