

# Series 84-4HF, 84-4HR

## Technical details

<b>Temperature range</b>	0°C ... +60°C
<b>Operating pressure</b>	0 ... 8 bar
<b>Medium</b>	Filtered, oil-free and dried compressed air according to ISO 8573-1:2010, Class 7:2:4, instrument air, free of aggressive additives. Alternatively the pressure dew point must be at least 10°C below lowest occurring ambient temperature.
<b>Materials</b>	Body: Al (anodized), plastic, seals: NBR , inner parts: Al, steel



Hand lever operated spool valve.

### 5/2-way-valves

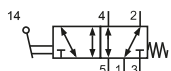

**84-4HF-xx-510**  
5/2-way, hand lever, mechanical spring return

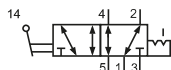

**84-4HR-xx-520**  
5/2-way, two positions, hand lever, detent

Please complete: xx = 18 for G1/8  
xx = 14 for G1/4  
xx = 12 for G1/2

### 5/2- and 5/3-way-valves

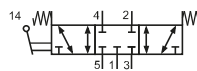

**84-4HF-xx-530**  
5/3-way, center position closed, hand lever, spring return

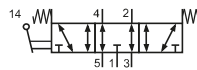

**84-4HF-xx-533**  
5/3-way, center position exhausted, hand lever, spring return

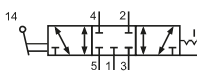

**84-4HR-xx-530**  
5/3-way, center position closed, hand lever, detent

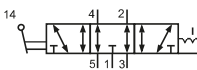

**84-4HR-xx-533**  
5/3-way, center position exhausted, hand lever, detent

## Technical data

Model-no.:	84-4HF-18-510	84-4HF-14-510	84-4HF-14-530	84-4HF-14-533
<b>Connection</b>	G1/8	G1/4	G1/4	G1/4
<b>Nominal size (mm)</b>	4.5	6	5	5
<b>Flow rate (NI/min)</b>	750	1350	980	980
<b>Weight (kg)</b>	0.168	0.252	0.310	0.310

Model-no.:	84-4HR-18-520	84-4HR-14-520	84-4HR-12-520	84-4HR-14-530	84-4HR-14-533	84-4HR-12-530
<b>Connection</b>	G1/8	G1/4	G1/2	G1/4	G1/4	G1/2
<b>Nominal size (mm)</b>	4.5	6	8	5	5	6.5
<b>Flow rate (NI/min)</b>	750	1350	2500	980	980	1600
<b>Weight (kg)</b>	0.170	0.255	0.540	0.250	0.250	0.560

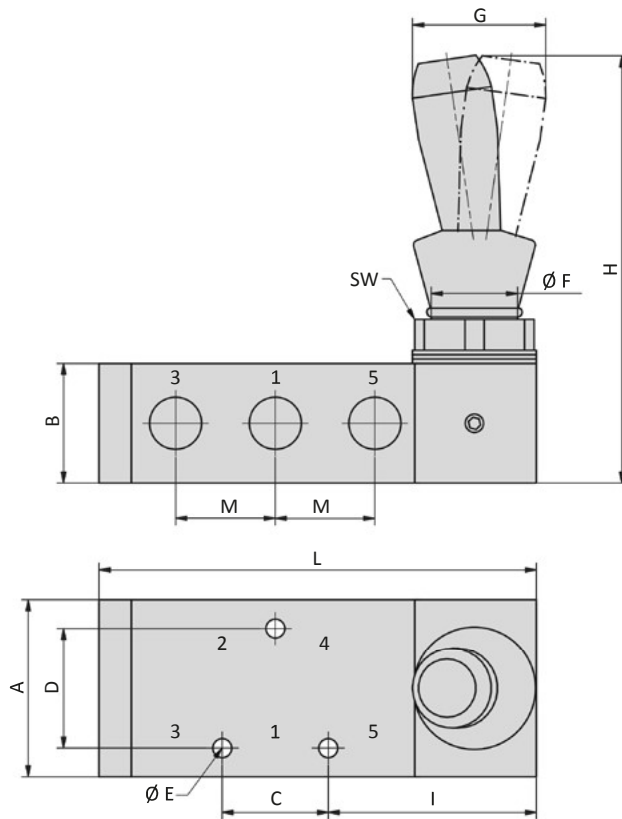
**Dimensions**

- 1 = pressure inlet
- 2,4 = outlets
- 3,5 = exhausts

	A	B	C	D	Ø E	Ø F	G	H	I	L	M	SW
<b>84-4HF-18-510</b>	35	22	20	21	4.3	15	16	90	38	81.3	18	22
<b>84-4HF-14-510</b>	40	27	24	27	4.3	20	20	93	48	100.5	22.5	27
<b>84-4HF-14-530</b>	40	27	24	27	4.3	20	20	93	67	119.5	22.5	27
<b>84-4HF-14-533</b>	40	27	24	27	4.3	20	20	93	67	119.5	22.5	27
<b>84-4HR-18-520</b>	35	22	20	21	4.3	15	16	90	38	81.3	18	22
<b>84-4HR-14-520</b>	40	27	24	27	4.3	20	20	93	48	100.5	22.5	27
<b>84-4HR-14-530</b>	40	27	24	27	4.3	20	20	93	48	100.5	22.5	27
<b>84-4HR-14-533</b>	40	27	24	27	4.3	20	20	93	48	100.5	22.5	27
<b>84-4HR-12-520</b>	50	34	28	35	5.5	22	28	103.5	57	128.5	31.5	-
<b>84-4HR-12-530</b>	50	34	28	35	5.5	22	30	108.5	57	128.5	31.5	27